



Universal Process-Controller

For monitoring press-fit and joining operations, torque and process curves, plus spring and switch testing, including resistance measurement, signal testing and leak detection

DIGIFORCE®

Series 9307



Compatible sensors



Application

The DIGIFORCE® 9307 monitors processes in which precisely defined functional relationships between two or more measured quantities need to be demonstrated. These measured quantities are recorded synchronously during the manufacturing process or subsequent functional testing to produce a measurement curve, which is then assessed using graphical and mathematical evaluation techniques. After internal evaluation, the measurement curve and computed evaluation results are visualized on the color display and are also output at the external control interfaces. The processes in the controller are optimized by a powerful real-time operating system to achieve an extremely fast evaluation cycle: it typically takes just 20 ms to deliver the global OK or NOK evaluation result, which can then be analyzed by the higher-level controller.

In addition to the traditional evaluation windows with defined entry and exit sides, the DIGIFORCE® 9307 also offers thresholds, trapeziums of type X or Y and envelopes as graphical evaluation elements. Individual evaluation results from the graphical tools can then be combined by mathematical operations to provide even more analysis flexibility for a huge range of signal curves.

DIGIFORCE® has a wide range of process control applications, including monitoring processes such as joining, riveting or caulking, or checking torque curves, for instance for hinges or high-quality rotary controls. Even complex signal/time curves (e.g. pressure curves, leaks etc.) can be monitored using the large choice of evaluation techniques.

Simultaneous recording of up to two Y variables (Y_1 and Y_2) with respect to a common X variable allows many applications to



- Comprehensive process monitoring delivered by innovative evaluation elements window, thresholds, trapeziums, envelopes and mathematical operations
- High measurement accuracy 0.05 % possible at 10 KHz sampling rate
- Flexible process integration thanks to a range of Fieldbus interfaces
- Simultaneous monitoring of two synchronous processes
- Ultra-fast evaluation and data transfer for dynamic measurements
- Ethernet, USB, RS232 as standard
- Up to 128 measurement programs for a large variety of parts
- Transfer of process, component and worker data
- Intelligent signal sampling using a combination of Δt , ΔX , ΔY
- Independent and variable start/stop logic
- Convenient configuration screens
- DigiControl PC software with powerful data-logging function for process data

use one DIGIFORCE® controller to monitor two synchronous processes.

Alternatively, this feature can be used to evaluate an application with three process variables, for instance the force/displacement curve and associated current consumption of a lifting electromagnet. While DIGIFORCE® is used in many automated production areas, it is equally at home in the manual workstation, for instance to monitor force/displacement when using hand presses for assembly or for random spot-checking in goods inwards.

Block diagram

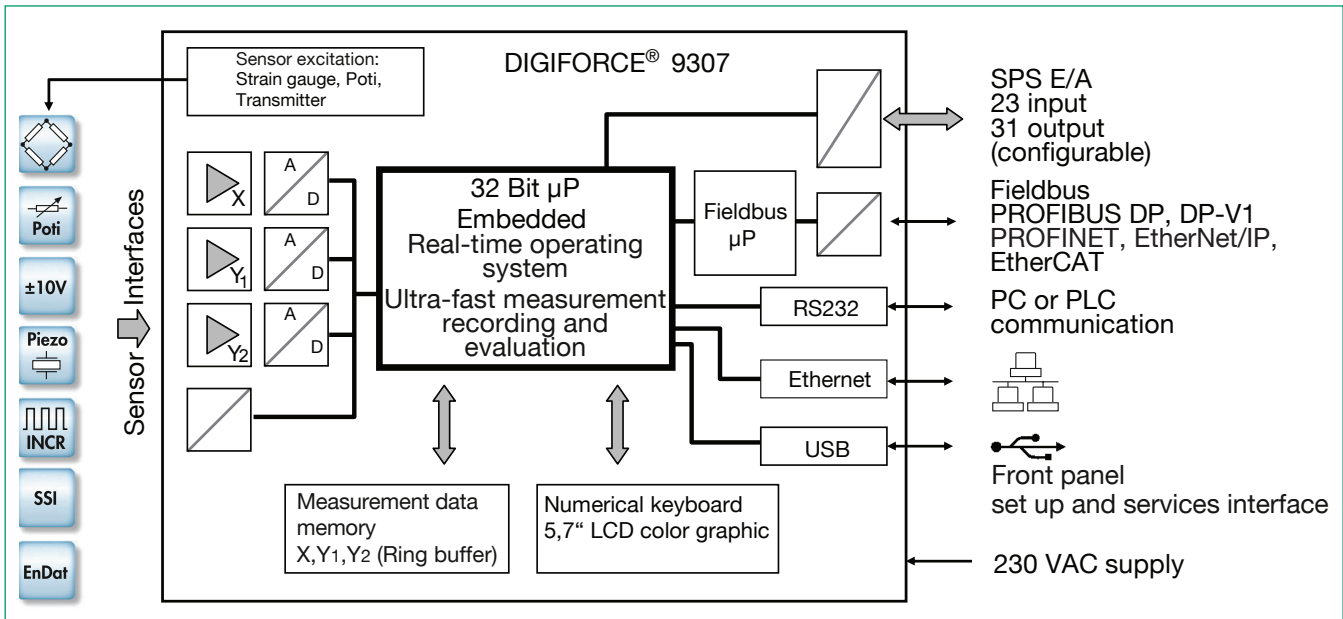

Measurement data acquisition

With an active measurement, which can be triggered by different events, the synchronously measured quantities X, Y₁ and optionally Y₂ are saved in the measurement data memory. Real-time signals can indicate whether measurements are exceeding set signal levels while the measurement is still in progress. The evaluation phase follows immediately after the measurement. In this phase, DIGIFORCE® checks whether the recorded measurement curve(s) satisfy the stored graphical and mathematical evaluation criteria. If any of these criteria has been infringed, the measurement is classified as BAD (NOK), otherwise it is rated as GOOD (OK). Once this evaluation is complete, the measurement curve, the global OK or NOK result and numerous process-related values are displayed in a suite of measurement windows and updated at the Fieldbus interface. The processing steps of the evaluation phase, which finishes when the equipment is ready for the next measurement, have been optimized so that even dynamic manufacturing processes can be monitored.

Evaluation of a measurement curve

As a universal evaluation tool for a vast range of curve shapes, the DIGIFORCE® 9307 provides configurable evaluation elements, which can be used to classify a measurement curve as OK or NOK. In addition to the traditional evaluation windows with defined entry and exit sides, the DIGIFORCE® 9307 also uses thresholds, trapeziums of type X or Y and envelopes as graphical evaluation elements. Individual evaluation results from the graphical tools can then be combined by mathematical operations to provide even more analysis flexibility for a range of signal curves. The graphical evaluation elements can be configured both numerically and graphically in setup mode using one or more recorded measurement curves. They can be used in any combination, even overlapping in an X/Y graph.

Window evaluation

Symbol

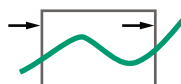

Max. number: 10

The Window evaluation element tests whether the curve has passed through the defined entry side and exit side in the window area. The user can configure these entry/exit sides as required, and can even set multiple input/output sides. A live signal can be assigned to up to two windows, which is enabled immediately during recording if any infringement occurs. It is also possible to define windows of type NOT (no entry/exit) or BLOCK (curve ends inside the window) by suitable configuration of the entry/exit sides. This evaluation element also calculates the values listed below, which can optionally be displayed and also input to user-definable mathematical functions for further processing and evaluation:

- ▶ Entry and exit coordinates (measurement pairs)
- ▶ Local minimum/maximum
- ▶ Absolute minimum/maximum
- ▶ Mean value Y_{Mean}
- ▶ Integral (area below curve to Y_{MIN} limit inside window)
- ▶ Curve gradient
- ▶ Inflection point

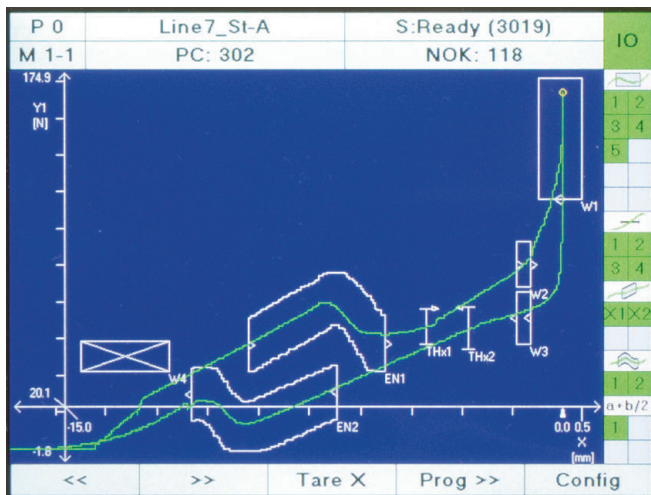
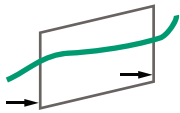

Figure: Measurement window M1-1 contains a graph of the measurement curve. Shows a curve containing a forward and return section and detailed evaluation using windows, envelopes, thresholds and mathematical operations.

Trapezium evaluation element

Symbol



Max. number: 4

The DIGIFORCE® 9307 offers two different types of trapezium: the type-X trapezium window with fixed X_{MIN} , X_{MAX} limits and type-Y trapezium with fixed Y_{MIN} , Y_{MAX} limits. The trapezium evaluation element tests whether the curve has passed through the defined entry and exit sides; only one entry side can be configured for this element. The entry/exit values are calculated.

Threshold evaluation element

Symbol

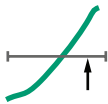

Max. number: 4

The threshold evaluation element can be used to calculate and monitor where the measurement curve passes through a defined X-value or Y-value. The user can choose between threshold type X or Y. Threshold type Y provides the following extra results:

- ▶ Local minimum/maximum
- ▶ Absolute minimum/maximum
- ▶ Mean value Y_{Mean}
- ▶ Integral (area between curve and X-axis in the threshold region X_{MIN} to X_{MAX})
- ▶ Curve gradient
- ▶ Inflexion point

Envelope evaluation element

Symbol

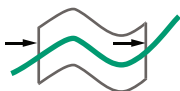

Max. number: 2

The DIGIFORCE® 9307 can use one or more measurement curves to generate up to two envelopes. The user can then customize a generated envelope in the X-domain, and also set tolerances for the Y-domain. For a measurement curve comprising a forward and return curve section, the envelope cannot lie over the turning point.

When subsequently monitoring a measurement in measurement mode, DIGIFORCE® tests whether the measurement curve lies within the defined envelope band i.e. is classified OK, or whether the curve passes outside the valid envelope and hence must be classified NOK.

Rotary switch evaluation element

Symbol

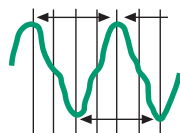

Max. number: 2

The Rotary switch evaluation element enables haptic testing of rotary switches and rotary or rotating controls comprising up to 32 control positions. This evaluation tests whether the number and level of force maxima and minima satisfy the saved criteria. In addition, the angular distance and Y-mean value of the extreme values will be monitored.

Mathematical operation

Symbol

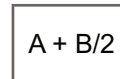

Max. number: 10 of which 6 can be evaluation

Specific measurement curve variables and results from the graphical evaluation elements can be combined using basic mathematical operators (+, -, x, ÷) and evaluated. A result can be processed further in a subsequent operation. The evaluation is fed into the global evaluation result. The results of a mathematical operation can be displayed in a measurement window and retrieved via the Fieldbus and/or communication interfaces.

Flexible process integration

The DIGIFORCE® 9307 has the versatility to integrate into practically all process environments. A huge number of detailed requirements can be implemented using the numerous I/Os (23 inputs / 31 outputs), some of which can be assigned user-defined functions. A measurement can be started and terminated at variable times by different internal and external events.

Sampling and recording measurement signals

Signals can be sampled as a combination of time interval (Δt), X-interval and Y-interval (ΔX , ΔY) to provide a flexible yet also compressed measurement recording. Curve areas containing a constant or steadily changing signal can be reproduced with just a few stored measurement points, while steep signal slopes or alternating waveforms require many points.

Start/Stop conditions for measurement recording

The DIGIFORCE® 9307 lets the user define independent start/stop logic.

Start conditions: Ext. control signal, measurement above or below a definable X-value or Y-value.

Stop conditions: Ext. control signal, measurement above or below a definable X-value or Y-value, timeout, definable number of recorded measurements reached.

Recording and evaluating two synchronous processes

Two signal curves Y_1 and Y_2 can be recorded with respect to a common X-channel and evaluated in one measurement phase. For the evaluation, the user assigns the required graphical evaluation elements to each graph, and the evaluation is performed independently using separate process signals (OK- $Y_{1/2}$). Alternatively, it is possible to monitor an application that has three process variables.

Limit monitoring in real time

S1 ... S4

The user is able to assign the switching signals S1 ... S4 to the three measurement channels X, $Y_{1/2}$ as required, and can set their polarity. The associated PLC I/Os and Fieldbus signals are updated both in standby mode and also in real time during the measurement cycle (response time < 10 ms).

NOK ... ONLINE_{1/2} Up to two live signals (NOK-ONLINE_{1/2}) can be used if the curve does not pass through the permitted region of the window evaluation element. This allows pre-emptive termination of a joining process in ultra-quick time if the two components get intertwined, protecting parts, tools or even the entire system from damage.

Process data

The DIGIFORCE® 9307 visualizes a comprehensive set of process data during measurement mode and automatic production mode. All relevant process data can be transferred to the controller or PC environment immediately after a measurement. The user can switch between the following process windows:

- ▶ M1-1/2 Graph of $Y_1(X)$ or $Y_2(X)$ measurement curve
- ▶ M1-3 Shared display of $Y_{1/2}(X)$ curves
- ▶ M2-1/2 General display of $Y_1(X)$ or $Y_2(X)$ curves
- ▶ M3 Full-screen PASS/FAIL or smiley
- ▶ M4 Entry/exit data for evaluation elements
- ▶ M5 List of user-specific process values (up to 24 values)
- ▶ M6 Statistics on all graphical evaluation elements (trend/histogram)
- ▶ M7 Job sheet containing process, worker and parts data

Each process window displays the global header containing information on the selected measurement program, the associated part quantities and NOK figures, and the global OK/NOK evaluation. The status field on the right shows the evaluation elements that are active in the measurement program and their individual results.

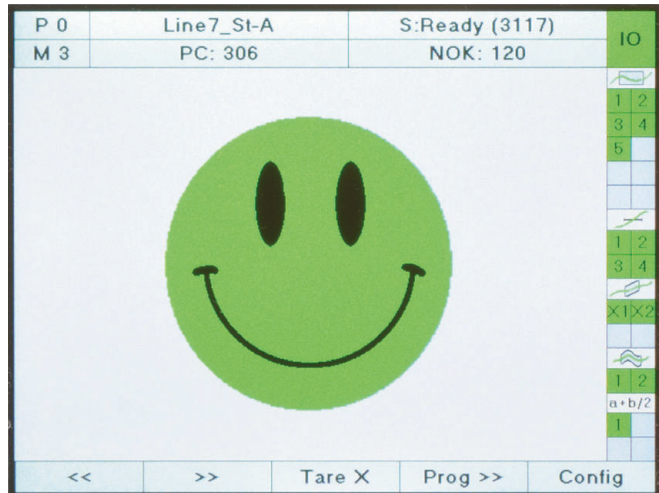

Figure: A full-screen smiley is an internationally understood symbol for the global OK/NOK evaluation (alternatively can display PASS/FAIL).

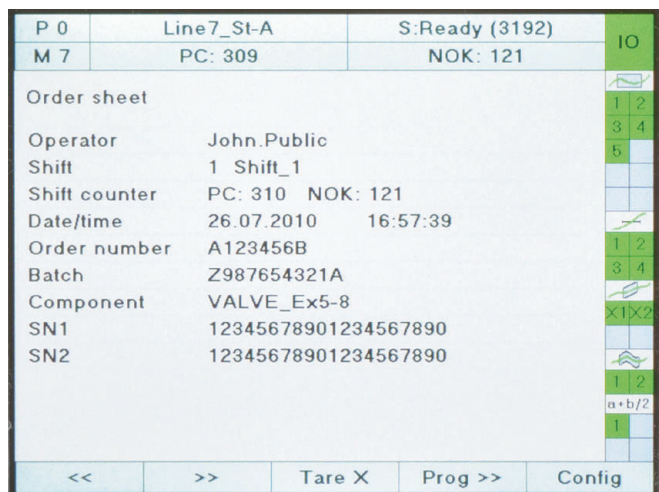

Figure: The job sheet is used to transfer administrative and component-related data from the PLC to the PC for process data logging.

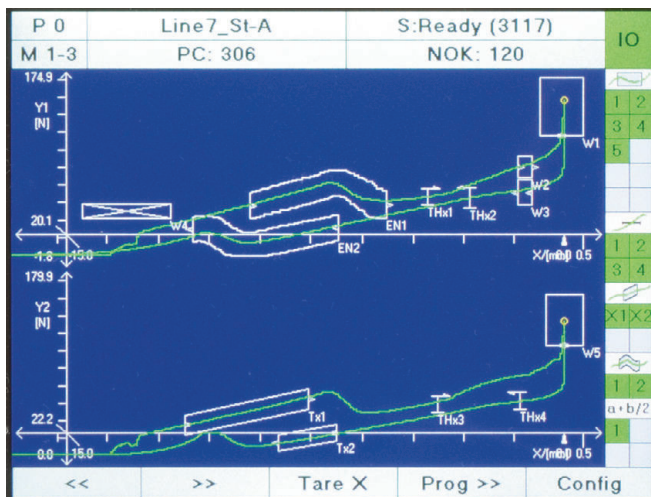

Figure: Display showing the two measurement curves $Y_1(X)$ and $Y_2(X)$

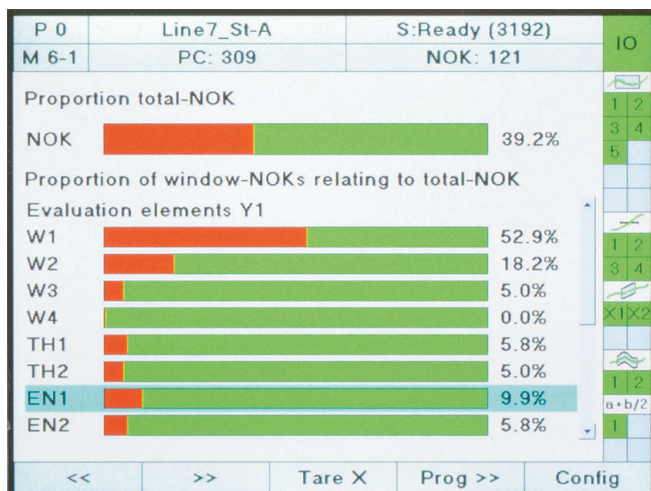

Figure: Statistics showing the frequency and distribution of NOK evaluations. It is also possible to display a trend diagram and histogram for the entry/exit data for each active graphical evaluation element.

Sensor configuration and calibration

The user can choose which physical channels A...F to assign to the measurement graphs (X, $Y_{1/2}$ coordinates) and set the graph scale. This gives the user the freedom, for instance, to use a preferred mounting for a displacement sensor, and then set the scale to display/evaluate a decreasing or increasing, positive or negative displacement. The sensor is calibrated either from the sensor certificate data or else by the teach-in process.



Fieldbus interface

An independent communication processor provides the Fieldbus interface via PROFIBUS, PROFINET, EtherCAT or EtherNet/IP.

Cyclical realtime process data

- ▶ Process control
- ▶ Retrieval of specific measurement results
- ▶ Live values of the active sensors

Non cyclical parameter/ADMIN/result data

- ▶ Transfer of component/worker/job data for logging
- ▶ Complete device configuration
- ▶ Retrieval of large amounts of process and curve data

32/128 measurement programs

The DIGIFORCE® 9307 comes with the capability to manage up to 32 measurement programs, which can be rapidly selected via I/O, Fieldbus or keypad. Each measurement program contains the full configuration of sensors, measurement procedure and evaluations. The PC software DigiControl can be used to download alternative DIGIFORCE® 9307 firmware, which has the capability to handle up to 128 measurement programs. This firmware re-allocates the internal memory so that up to 400 measurement pairs/triplets can be recorded.

DIGIFORCE® 9307 and PC software DigiControl – a high performance package

The DIGIFORCE® 9307 is a fully autonomous test controller that not only displays status information and evaluation results in its process environment but can also transmit this data to a controller. The high-performance DigiControl software package has additional functions to further increase process availability and reliability.

A **basic version**, which is available free of charge, includes applications for creating data backups (up/download) and for saving a comprehensive set of service data for optimum support by the burster service team.

The **config version** (9307-P101) supports full device configuration, creation of backups, and retrieval and display of measurement curves, including all evaluation results and statistics. An especially convenient feature is the definition of graphical evaluation elements such as envelopes, windows, trapeziums and thresholds based on a set of curves of measured master or reference parts. Alternatively, ready-archived measurements can also be used to create new evaluations. Clearly structured configuration windows enable convenient device setup. Changes can be made step-by-step either at the file level or directly using the DIGIFORCE® 9307.

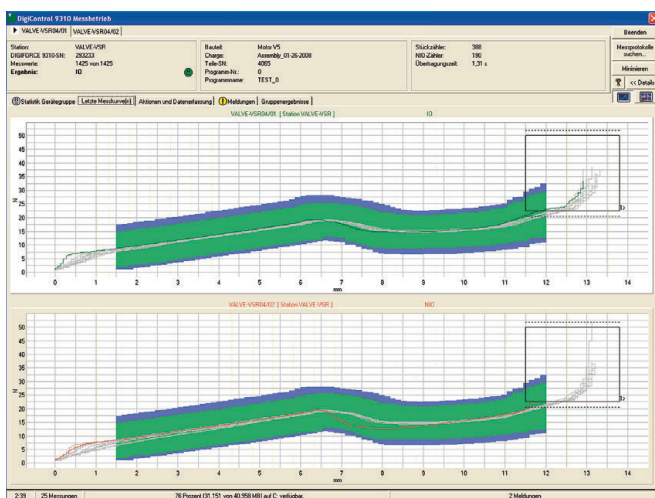

Figure: The „measurement mode“ function displays the curve and status information of the most recent measurement. A multi-channel view is also possible. The corresponding log is automatically saved in the background.

The intelligent sampling tool, with its facility to combine variables (Δt , ΔX and ΔY), ensures that these 400 value pairs are normally sufficient to reproduce and evaluate a measurement curve.

Internal measurement curve memory

In graphical setup mode, one or more imported measurement curves can be used to configure the evaluation elements. This is still possible even if the process requires a change in measurement program back at the setup stage. Up to ten measurement curves can be saved in each measurement program as a curve array, which then provides the basis for the evaluations to be defined. In measurement mode, this memory acts as a ring buffer, where the remaining 50 measurement curves are stored. The DigiControl PC software can be used to retrieve and analyze these measurements.

User-definable function keys

The function keys F1...F4 below the display can be assigned to various functions as required. The following functions are available for selection for example: browse measurement screens, tare, start/stop measurement, change program, confirm OK/NOK evaluations, sensor test.

The **Plus version** (9307-P100) of the PC software DigiControl provides, in addition to the standard functions, an automatic production mode, which, for example, logs production measurement data with clear parts references. The resultant measurement logs are not only available in the internal program format, but can also be imported into EXCEL data. Even for synchronous processes involving large amounts of data, logging of measurement data is optimized to achieve an ultra-short cycle time. In addition to the DIGIFORCE® device interface, it also supports an extra control interface for more complex tasks. This can be used, for instance, for reloading device configurations or transferring component references for measurement data logging.

Upgrade from DIGIFORCE® 9306 to DIGIFORCE® 9307

A DIGIFORCE® 9307 device configuration can be generated from a DIGIFORCE® 9306 backup file using DigiControl. The software imports the sensor and evaluation settings and selects as close a configuration as possible for the DIGIFORCE® 9307. Then just a few minor final adjustments and settings are needed to resume production under process control.

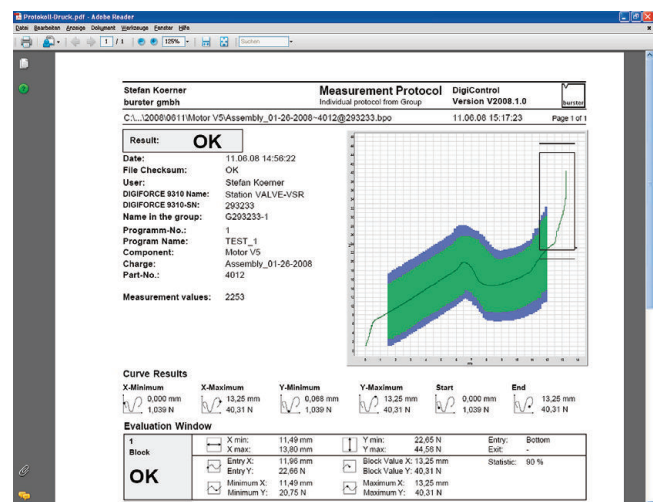

Figure: A Data-log wizard provides filters for selecting and displaying stored measurement logs. A log printout containing component data, curve information and all evaluation results can be generated for each individual measurement log.

General Technical Data

Sampling rate:	10 kHz
Signal sampling:	$\Delta X, \Delta Y, \Delta t$ in any combination
Measurement curves:	$Y_1(X)$ and $Y_2(X)$
Digitalization:	16 bit
Evaluation time:	20 ms
Measurement programs:	32 (5,000 value pairs)* / 128 (400 value pairs)
Power supply:	90 ... 240 VAC / 47 ... 63 Hz / typically 30 VA
Delay in real-time limit signals S1 ... S4:	< 10 ms
Operating temperature range:	+ 5 ... + 23 ... + 40°C
Protection class:	IP30 / IP65 panel-mounted
Display:	5,7" TFT LCD (640 x 480)
Keypad:	numerical, configurable function keys

* Factory-installed device firmware. Firmware can be changed via PC software DigiControl.

Compatible Sensors

Flexible assignment of physical channels A ... F to measurement graphs (X/Y_{1/2} coordinates)

Channel A, B (strain gauge, potentiometer, process signals)

Strain gauge sensors

Measurement ranges:	$\pm 1 \dots 40$ mV/V
Bridge resistance:	120 Ω ... 5 k Ω
Excitation voltage:	2.5 V, 5 V, 10 V
Excitation current:	35 mA or 70 mA @ 10 V
Cut-off frequency:	5 ... 5,000 Hz in discrete bands
Total error:	< 0.05 % F.S. @ ≥ 1 mV/V < 0.1 % F.S. @ < 1 mV/V

Potentiometer, process signals

Excitation voltage:	5 V / 10 V
Transmitter excitation:	24 V, 150 mA
Measurement ranges:	± 5 V, ± 10 V
Excitation current:	100 mA max.
Cut-off frequency:	5 ... 5,000 Hz in discrete bands
Total error:	< 0,05 % F.S.

Channel C incremental sensors, EnDat 2.2, SSI

Signal:	TTL / RS422, sinusoidal voltage 1 V _{pp} , sinusoidal current 11 μ A
Counter depth:	32 bit, ± 2 EXP31
Cut-off frequency:	1 MHz
Reference mark:	single, multipoint, distance-coded
Absolute value:	EnDat 2.2, SSI, reference travel for distance encoding
Transmitter excitation:	5 V, 300 mA

Channel D combined channel analog/incremental (option)

Strain gauge or process signal:	$\pm 1 \dots 40$ mV/V, ± 5 V, ± 10 V
Total error:	according to channels A, B
Incremental interface:	TTL/RS422, Sinus 1 V _{pp} , Sinus 11 μ A
Transmitter excitation:	5 V, 300 mA / 15 V, 200 mA

Channel E resistance measurement (option)

Measurement ranges:	200 m Ω , 2 k Ω , 100 k Ω
Total error:	< 0.5 % F.S. @ 200 m Ω , 2 k Ω < 1 % F.S. @ 100 k Ω

Channel F Piezoelectric (option)

Measurement ranges:	1 nC ... 1 μ C in discrete bands
Cut-off frequency:	5 ... 5,000 Hz in discrete bands
Total error:	< 1 % F.S.

Fieldbus Interfaces

I/O interface

Two parallel PLC ports to EN 61131-2, 24 VDC, opto-isolated
23 inputs D-SUB-37 (male)
31 outputs, of which 23 configurable, maximum load I_{MAX} 200 mA,
D-SUB-37 (female)

PROFIBUS (option)

D-SUB9	
Bau drate	max. 12 MBaud
Communication protocol	cyclic service DP-V0 acyclic service DP-V1

PROFINET, EtherNet/IP, EtherCAT (option)

2 port western-socket (RJ45)	
Communication protocol	cyclical realtime process data non cyclical parameter data

Communication Interfaces

Device parameterization, data backup (up/download), high-speed measurement data logging

USB	Slave port (model B) front panel Data rate ~ 1 Mbaud
RS232	D-SUB9 (PC connecting using 1 : 1 cable 9900-K333) Format 8.1 Data rate 9600 baud ... 115.2 Kbaud
Ethernet	10/100 Mbit, Western socket (RJ45)

Housing

Combined desktop/panel-mounted housing (W x H x D): 205 x 160 x 240 [mm]	
Desktop version:	4 rubberized feet (fitted as standard)
Front panel (W x H):	220 x 175 [mm]
Front panel cut-out (W x H):	206 x 161 [mm]
Weight:	approx. 5 kg

Accessories

Fixing kit for panel mounting **Model 9300-Z003**

PC software

PC software DigiControl: basic version for creating a data backup (up/download) and saving a service record included with device delivery and can be downloaded free from www.burster.com

PC software DigiControl: configuration software for convenient device configuration including backup function, USB data cable

Model 9307-P101

PC software DigiControl: PLUS version including high-speed, in process logging of measurement data, Data-log wizard, EXCEL data export

Model 9307-P100

Cables and connectors

Connecting cable for burster displacement sensors
8710 ... 8719 series, length 3 m **Model 99209-591A-0090030**

Connecting cable for torque sensor model 8651/8661 incl. angular measurement to option channel D, length 3 m
Model 99163-540A-0150030

Adapter cable (Y-type) for torque sensor model 8661 incl. angular measurement to standard channels A/B and C (only to use together with model 99163-540A-015xxxx) **Model 99209-215A-0090004**

Connecting plug for A, B and E channel, D-SUB-9
(pack of 2 included with device) **Model 9900-V209**

Connecting plug for C and D channel, D-SUB-15 **Model 9900-V163**

Adjustment of a complete measuring chain

Adjustment and scaling of up to 3 sensors including test certificate
93ABG

Order Code

DIGIFORCE®	9307	- V	<input type="checkbox"/>	<input type="checkbox"/>	<input type="checkbox"/>	<input type="checkbox"/>
	Standard		0	0	0	0
Analog option			X	1	X	X
Piezo interface						
Combined channel analog / INCR (D) and resistance measurement (E)			X	2	X	X
Fieldbus option			X	X	X	1
EtherCAT			X	X	X	2
PROFIBUS (DP-V0/DP-V1)			X	X	X	3
PROFINET			X	X	X	3
EtherNet/IP			X	X	X	4

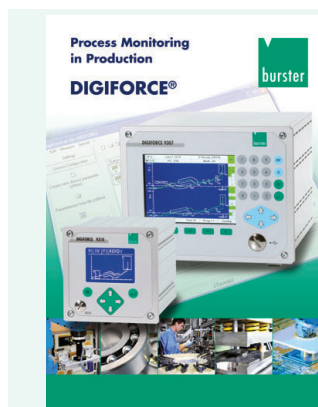

Please request
our
brochure

**"DIGIFORCE®
Process Monitoring
in Production".**

It contains numerous
applications,
a detailed
product specification and
a look
at a range
of compatible sensors.